



**HIGH
RATE
MAX^{XT}**



UPS12-520MRX

Valve Regulated Lead Acid Battery
Designed for UPS Standby Power Applications.

APPLICATIONS

- Data Centers
- Network Operations Centers
- Industrial Process Control Facilities
- Internet Housing Sites
- Semiconductor Manufacturing
- Banks & Financial Markets
- Power Generation Plants
- Hospitals & Testing Laboratories
- Emergency 911 Response Centers

FEATURES & BENEFITS

- 10 year design life @ 25°C
- Absorbent Glass Mat (AGM) technology for efficient gas recombination of up to 99% and freedom from electrolyte maintenance.
- 3 Year Warranty (refer Dynasty warranty card, 41-9027)
- Patented Long Life Alloy having the lowest calcium levels in the industry - minimizing grid growth, reducing gassing, and extending battery life.
- Patented UL Recognized Flame-arresting vents in each cell for safety and long life.
- Designed with the same recombination, thermal runaway prevention, gassing and flame retardant characteristics of the Bell-core 4228 compliant Dynasty Telecom products.
- Flame retardant polypropylene case and cover compliant with UL94V-2
- Proprietary Fixed Orifice Plate Pasting technology applying active materials on both sides of the grid for consistent cell-to-cell performance, higher capacity and uniform grid protection.
- Thermally welded case-to-cover bond to eliminate leakage.
- Can be operated in any orientation. Upright, side or end mounting recommended.
- Not restricted for air transport - Complies with IATA/ICAO Special Provisions A67.
- Not restricted for surface transport - Classified as non-hazardous material as related to DOT-CFR Title 49 parts 171-189.
- Not restricted for water transport - Classified as non-hazardous material per IMDG Amendment 27.

TECHNICAL DATA

Model	Constant Power Discharge Ratings - Watts per Cell @ 25°C (77°F)										20 hour rate to 1.75 VPC @ 25°C	IEC Rating: 10 hour rate to 1.80 VPC @ 20°C
	Operating Time (in minutes) to 1.67 Volts per Cell											
	5	10	15	20	30	40	45	50	60	90		
UPS12-520MRX	884	666	525	437	338	283	255	239	209	147	153 AH	135 AH

Cells Per Unit	Voltage Per Unit	Weight (Kg)	1 Min Current to 1.75VPC (Amps)	Short Circuit Current (Amps)	Internal Resistance (mOhms)
6	12.98	47.2	715	3586	3.50

SPECIFICATIONS

Operating Temperature Range with temperature compensation	Discharge: -40°F (-40°C) to +160°F (71°C) Charge: -10°F (-23°C) to +140°F (60°C)
Nominal Operating Temperature Range	+74°F (23°C) to +80°F (27°C)
Recommended Maximum Charging Current Limit	C/5 amperes @ 20hr rate
Float Charging Voltage	13.65 ± 0.15 VDC average per 12V unit
Maximum AC Ripple (Charger)	0.5% RMS or 1.5% P-P of float charge voltage recommended for best results. Max voltage allowed = 1.4% RMS (4% P-P) Max current allowed = C/20
Self Discharge	Battery can be stored up to 6 months at 77°F (25°C) before a freshening charge is required. Batteries stored at temperatures greater than 77°F (25°C) will require recharge sooner than batteries stored at lower temperatures. See C&D brochure 41-7272, Self-Discharge and Inventory Control for details.
Equalize charge and cycle service voltage	14.40 to 14.80 VDC average per 12V unit @ 77°F (25°C)
Terminal	Threaded copper alloy insert terminal to accept 1/4-20 UNC bolt.
Terminal Hardware Initial Torque	110 in.-lbs. (12.4 N-m)

DIMENSIONS

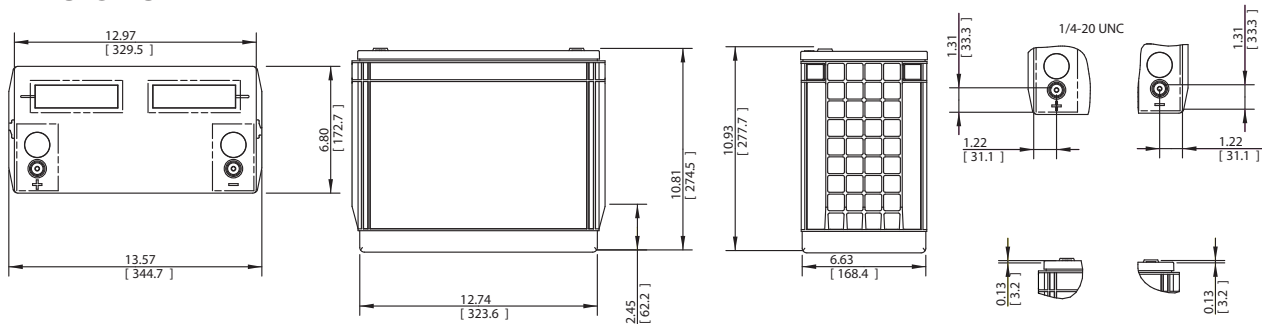

CONSTANT POWER DISCHARGE RATINGS

Constant Power Discharge Ratings - Watts Per Cell @ 20°C (68°F)										
Operating Time To End Voltage (in minutes)										
End Point Volts/Cell	5	10	15	20	30	40	45	50	60	90
1.75	737	574	458	388	307	260	236	223	197	139
1.70	793	609	480	403	315	265	240	227	199	141
1.67	831	626	493	412	320	269	243	229	200	141
1.65	859	637	503	419	324	271	245	231	202	142

Constant Power Discharge Ratings - Watts Per Cell @ 77°F (25°C)										
Operating Time To End Voltage (in minutes)										
End Point Volts/Cell	5	10	15	20	30	40	45	50	60	90
1.75	784	611	487	412	324	273	248	233	205	145
1.70	843	648	511	428	333	279	252	237	207	146
1.67	884	666	525	437	338	283	255	239	208	147
1.65	914	678	535	444	342	285	257	241	210	148

CONSTANT CURRENT DISCHARGE RATINGS

Constant Current Discharge Ratings - Amperes @ 20°C (68°F)									
Operating Time To End Point Voltage (in hours)									
End Point Volts/Cell	1	2	3	5	8	10	12	20	24
1.85	92.4	52.2	36.7	23.6	15.7	13.0	11.1	7.09	6.05
1.80	97.8	54.9	38.6	24.7	16.4	13.5	11.5	7.35	6.26
1.75	101	56.3	39.5	25.2	16.7	13.8	11.7	7.46	6.35

Constant Current Discharge Ratings - Amperes @ 77°F (25°C)									
Operating Time To End Point Voltage (in hours)									
End Point Volts/Cell	1	2	3	5	8	10	12	20	24
1.85	96.3	54.2	38.1	24.4	16.2	13.3	11.4	7.28	6.21
1.80	102	57.1	40.0	25.5	16.9	13.9	11.8	7.54	6.42
1.75	105	58.5	40.9	26.1	17.2	14.1	12.0	7.65	6.52

C&D TECHNOLOGIES, INC.

1400 Union Meeting Road
P.O. Box 3053 • Blue Bell, PA 19422-0858
(215) 619-2700 • Fax (215) 619-7899 • (800) 543-8630
customersvc@cdtechno.com
www.cdtechno.com

Any data, descriptions or specifications presented herein are subject to revision by C&D Technologies, Inc. without notice. While such information is believed to be accurate as indicated herein, C&D Technologies, Inc. makes no warranty and hereby disclaims all warranties, express or implied, with regard to the accuracy or completeness of such information. Further, because the product(s) featured herein may be used under conditions beyond its control, C&D Technologies, Inc. hereby disclaims all warranties, either express or implied, concerning the fitness or suitability of such product(s) for any particular use or in any specific application or arising from any course of dealing or usage of trade. The user is solely responsible for determining the suitability of the product(s) featured herein for user's intended purpose and in user's specific application.