



EnerRocket™
CONTINUOUSLY SAFEGUARDING

ESC 200-12 FR

SMF VRLA RECHARGEABLE BATTERY

**LONG
LIFE
SERIES**

APPLICATIONS

- UPS Systems
- Telecommunication Systems
- Fire Alarm Safety & Security Systems
- Medical Equipment

COMPLIANCE STANDARDS

- IEC 60896 PART 21 & 22
- BS6290-4
- EUROBAT- HIGH Performance

TECHNICAL FEATURES



- Non-Spillable Sealed Construction
- Absorptive Glass Mat System (AGM System)
- ABS (Acrylonitrile Butadiene Styrene) construction
- Gas Recombination
- Venting System for low internal pressure
- Low Self-Discharge
- Heavy-Duty, Highly Optimized Grids
- High Power Output

CHARACTERISTICS

Nominal Voltage	12 V	
Design Life	12 Years	
Capacity (25°C)	10 Hour rate	200Ah
Internal Resistance (25°C, 100% Charge)	≤4.0 mΩ	
Self Discharge (20°C)	1 Month	Remaining Capacity 97%
Operating Temperature	Discharge	-20°C - 60°C
	Charge	-10°C - 60°C
	Storage	-20°C - 60°C
Normal Operating Temperature	25°C ± 3°C	
Maximum Discharge current (25°C)	1000A (5sec)	
Maximum Charging current (25°C)	60A	
Short Circuit Current	3300A	
Charge Methods	14.4 to 14.7 V	
Constant Voltage Charge 77°F (25°C) - Cycle use	Temp. Compensation -30mV/°C	
Charge methods	13.4 to 13.8V	
Constant Voltage Charge 77°F (25°C) - Standby Use	Temp. Compensation -20mV/°C	

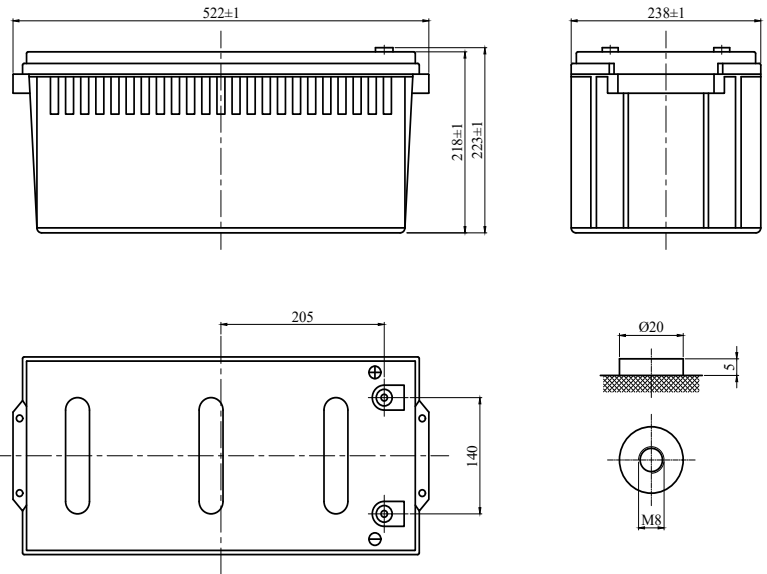

SPECIFICATIONS

Length	Width	Height	Total Height	Weight (kg)
522mm	238mm	218mm	223mm	59.1 ± 5%

CONSTANT CURRENT DISCHARGE (Amperes) AT 25°C

End Voltage Volts/Cell	15min	20min	30min	1h	1.5h	2h	3h	4h
1.60	327	280	196	129	91	71	50.3	44
1.65	308	269	188	126	88	68	49.1	43
1.70	288	259	181	123	85	65	48.2	41
1.75	269	250	175	120	83	64	47.1	40
1.80	250	240	168	117	80	62	45.7	39

CONSTANT POWER DISCHARGE (Watts) AT 25°C

End Voltage Volts/Cell	15min	20min	30min	1h	1.5h	2h	3h	4h
1.60	566	480	374	248	181	137	97.4	82
1.65	547	464	360	243	177	134	96.1	79
1.70	530	449	347	238	173	131	94.8	77
1.75	512	434	332	233	169	128	93.4	75
1.80	482	409	319	228	164	124	92.4	73



ESC 200-12 FR

SMF VRLA RECHARGEABLE BATTERY

**LONG
LIFE
SERIES**

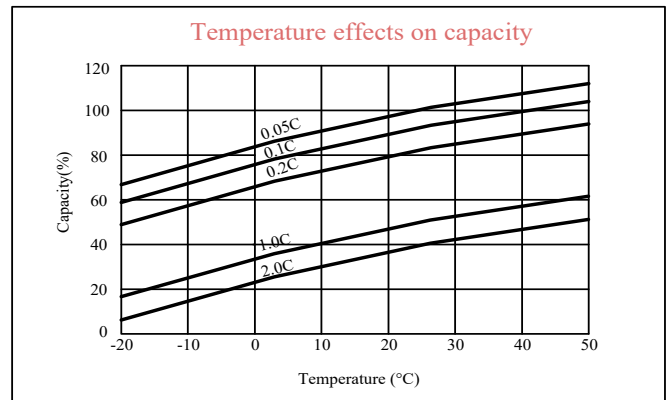
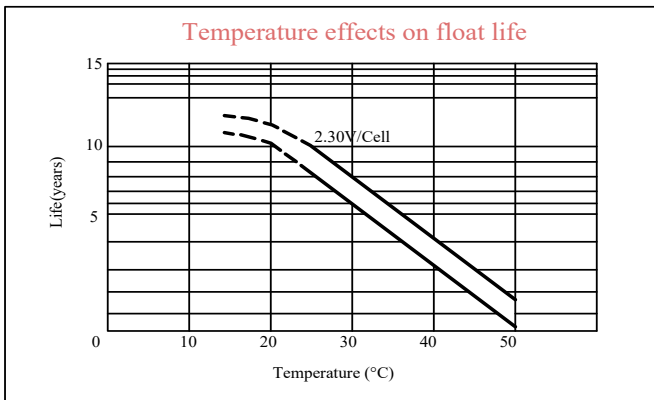
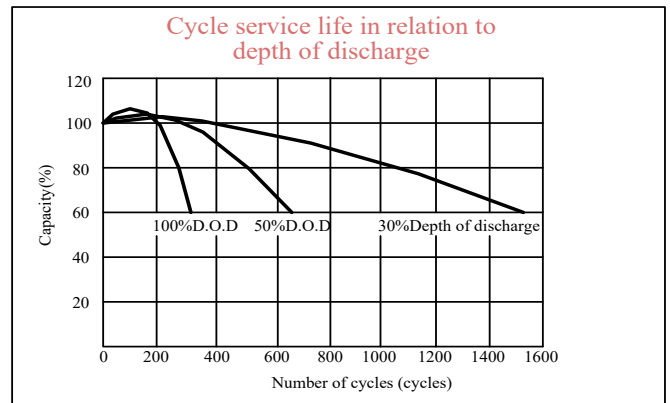
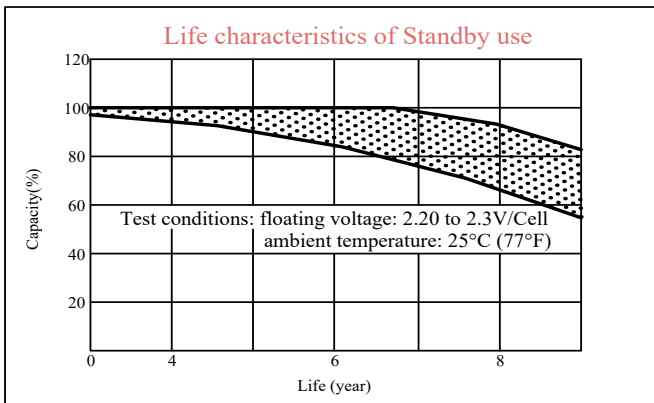
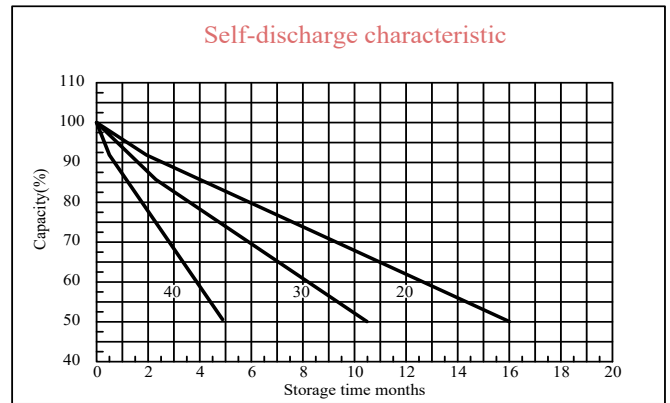
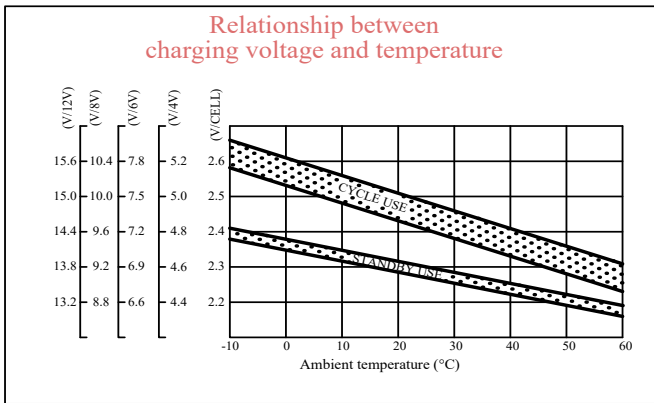
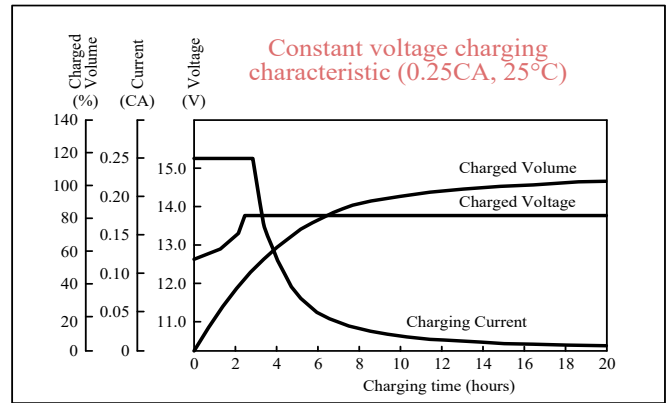
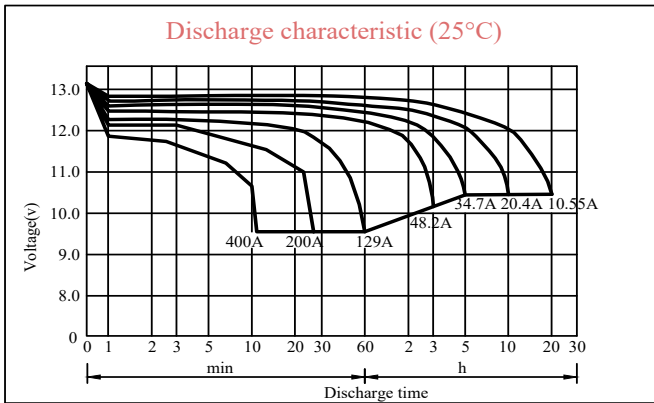

Note:
GPSGC reserves the right to make changes to the above values without any notice.
All data and discharge characteristics are average values based on actual discharge cycle tests performed and not minimum values.