



EnerRocket™
CONTINUOUSLY SAFEGUARDING

ESH 12-560W FR

SMF VRLA RECHARGEABLE BATTERY

HIGH RATE
LONG
LIFE
SERIES

APPLICATIONS

- UPS Systems
- Telecommunication Systems
- Fire Alarm Safety & Security Systems
- Medical Equipment

COMPLIANCE STANDARDS

- IEC 60896 PART 21 & 22
- BS6290-4
- EUROBAT- HIGH Performance

TECHNICAL FEATURES



- Non-Spillable Sealed Construction
- Absorptive Glass Mat System (AGM System)
- ABS (Acrylonitrile Butadiene Styrene) construction
- Gas Recombination
- Venting System for low internal pressure
- Low Self-Discharge
- Heavy-Duty, Highly Optimized Grids
- High Power Output

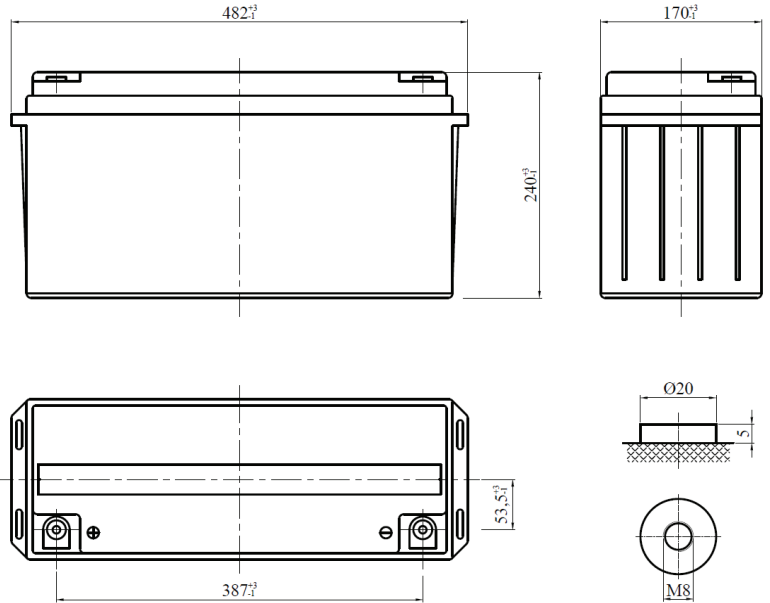

SPECIFICATIONS

Length	Width	Height	Total Height	Weight (kg)
482mm	170mm	240mm	240mm	45.0 ± 5%

CHARACTERISTICS

Nominal Voltage	12V	
Design Life	12 Years	
Capacity (25°C)	15min 1.67ECV	160 AH
Internal Resistance(25°C, 100% Charge)	≤3.5 mΩ	
Self Discharge (20°C)	1 month	Remaining Capacity 97%
Operating Temperature	Discharge	-20°C - 60°C
	Charge	-10°C - 60°C
	Storage	-20°C - 60°C
Normal Operating Temperature	25°C ± 3°C	
Maximum Discharge current (25°C)	970A (5sec)	
Maximum Charging current (25°C)	45A	
Charge Methods Constant Voltage Charge 25°C Cyclic Use	14.4 to 14.7V	
	Temp.Compensation -30mV/°C	
Charge Methods Constant Voltage Charge 25°C Standby Use	13.4 to 13.8V	
	Temp. Compensation -20mV/°C	

CONSTANT CURRENT DISCHARGE (Amperes) AT 25 °C

End Voltage Volt/Cell	3min	5min	10min	15min	20min	25min	30min	45min	60min
1.60V	597	501	411	332	284	245	208	139	107
1.65V	586	484	392	318	271	237	205	135	105
1.67V	582	477	387	312	266	234	204	133	104
1.70V	561	454	366	301	258	221	191	130	102
1.75V	543	444	354	291	252	218	186	127	101
1.80V	518	436	342	277	242	208	176	124	98

CONSTANT POWER DISCHARGE (Watts) AT 25 °C

End Voltage Volt/Cell	3min	5min	10min	15min	20min	25min	30min	45min	60min
1.60V	1147	915	722	600	502	431	370	267	210
1.65V	1130	892	684	571	483	416	362	258	204
1.67V	1123	883	668	560	476	410	359	255	202
1.70V	1103	864	654	550	463	401	347	250	200
1.75V	1076	844	615	527	450	386	333	242	193
1.80V	1047	806	601	502	432	372	320	234	190



ESH 12-560W FR

SMF VRLA RECHARGEABLE BATTERY

HIGH RATE
LONG
LIFE
SERIES

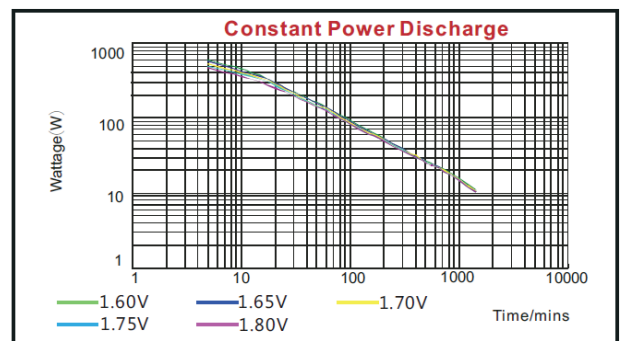
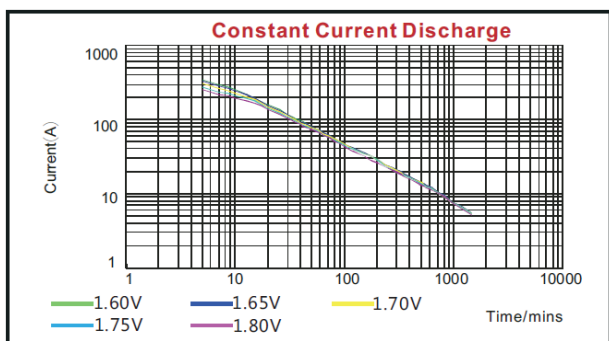
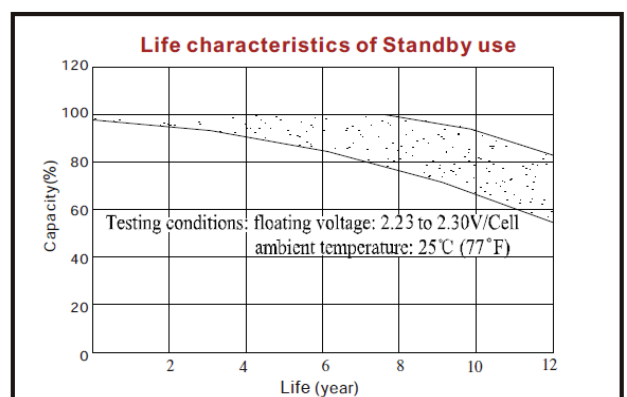
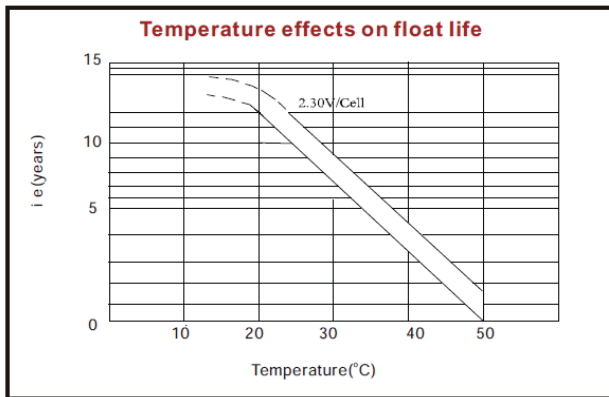
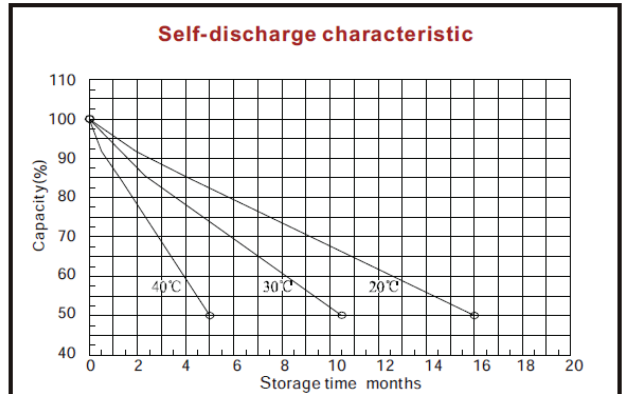
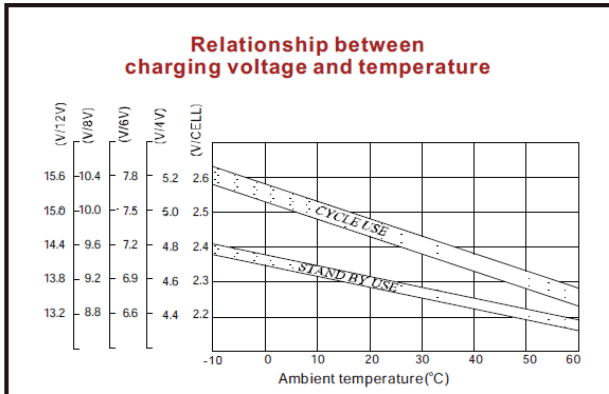
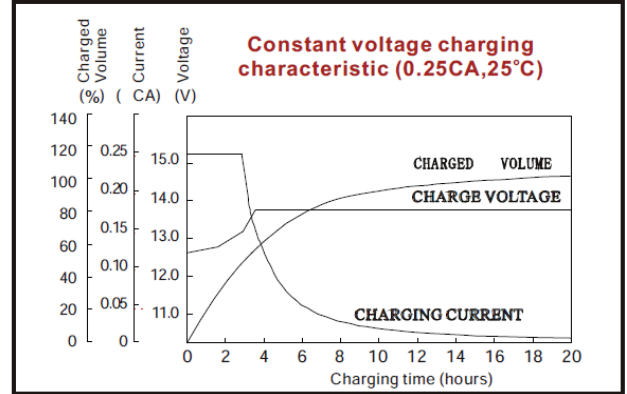
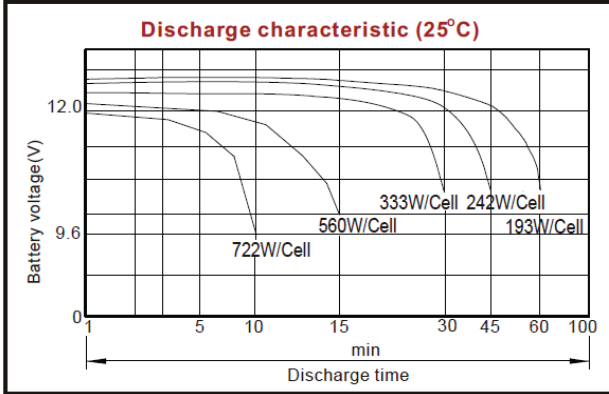

Note:
GPSGC reserves the right to make changes to the above values without any notice.
All data and discharge characteristics are average values based on actual discharge cycle tests performed and not minimum values.